

3.外形寸法図(貯湯ユニット)

(寸法単位:mm)

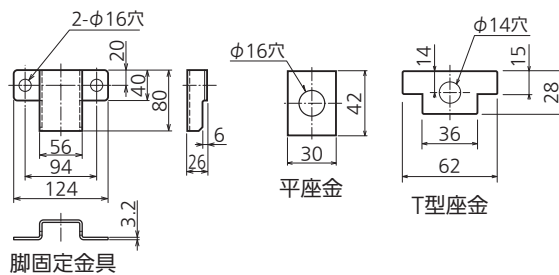
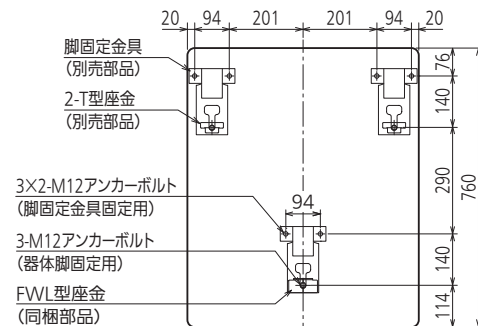
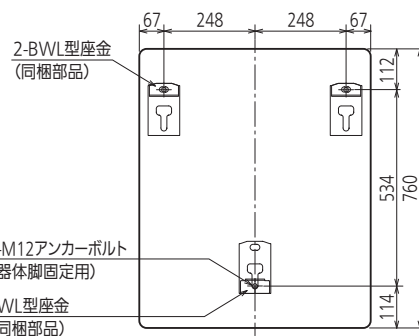
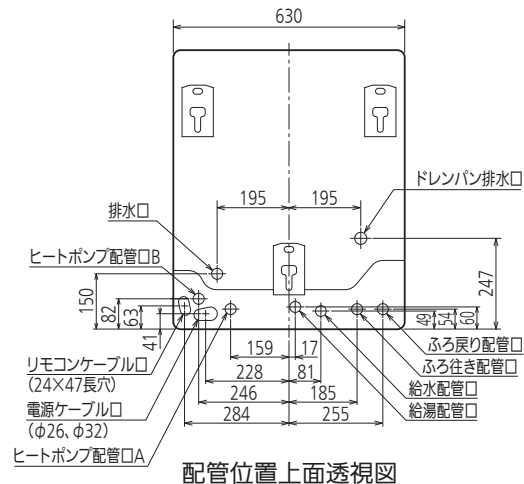
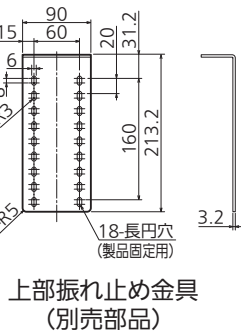
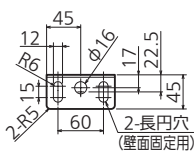
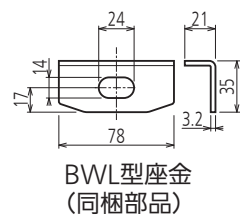
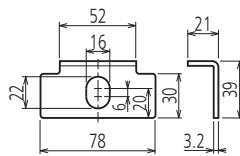
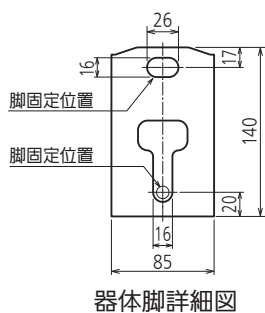
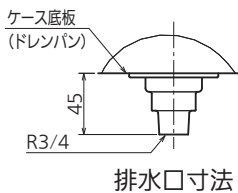
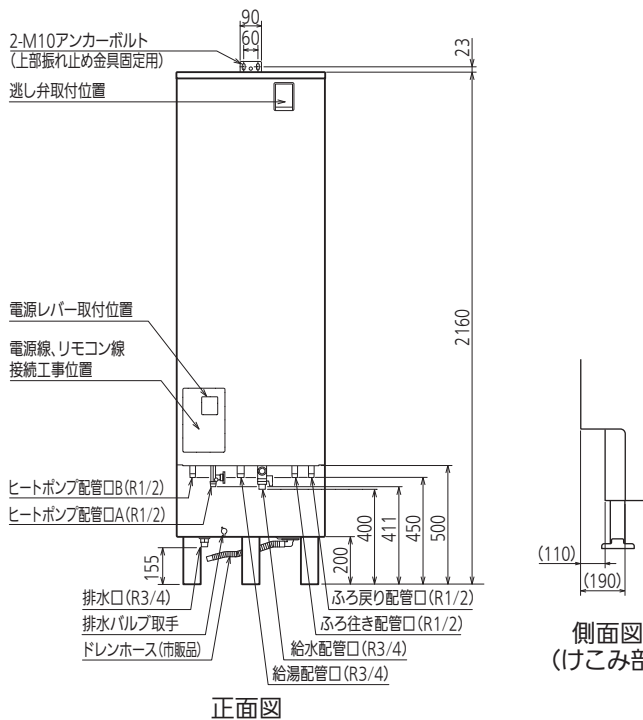
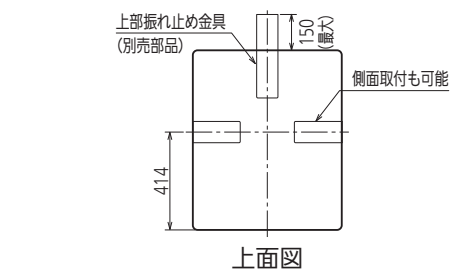

脚固定金具(別売部品)

4.外形寸法図(ヒートポンプユニット)

(寸法単位:mm)

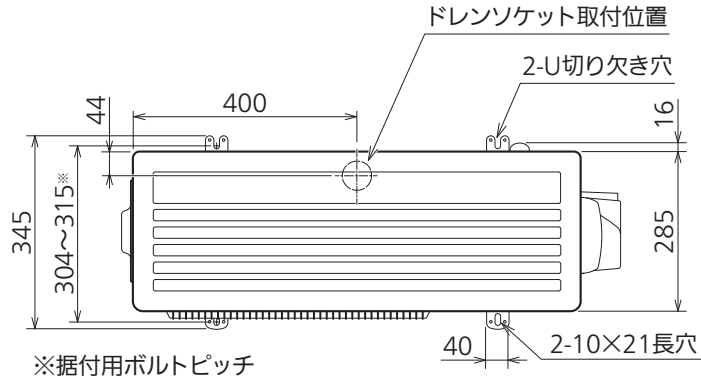

上面図

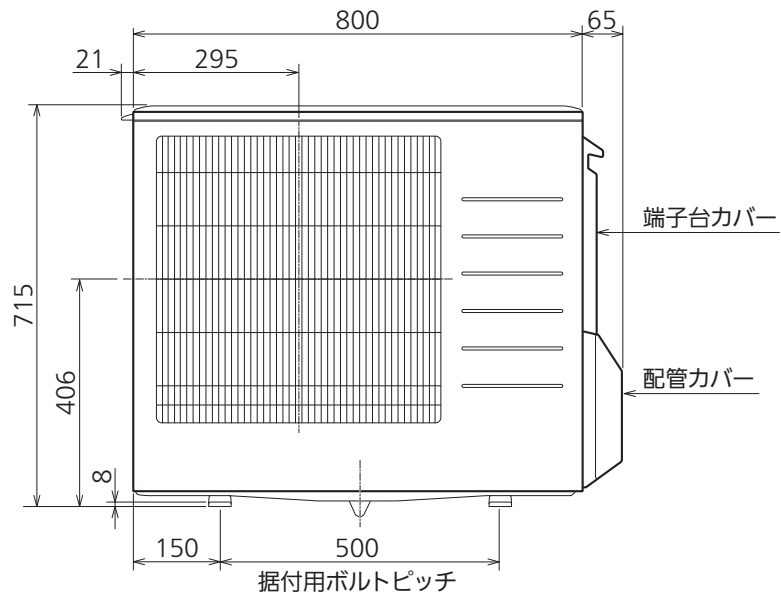

正面図

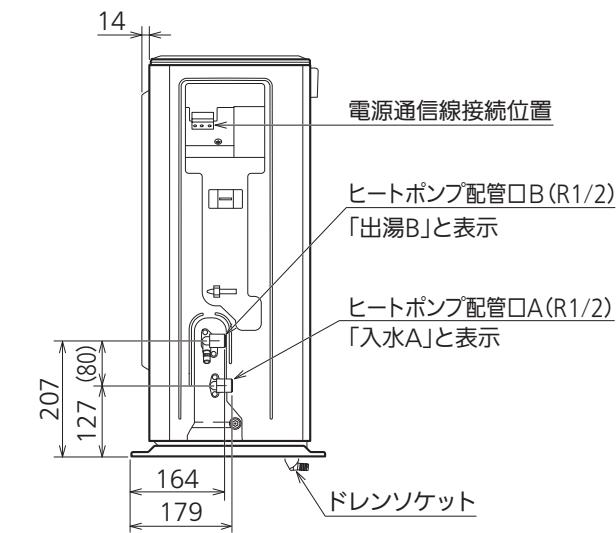

側面図

(配管カバー、端子台カバーを外した図)

