

# 4.外形寸法図

(寸法単位:mm)

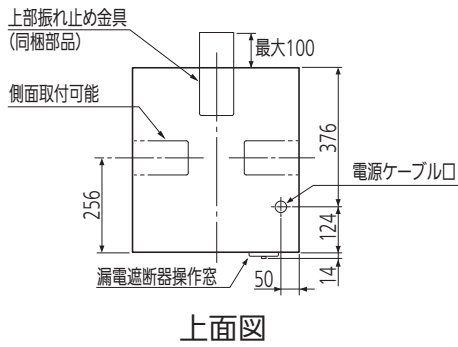

上面図

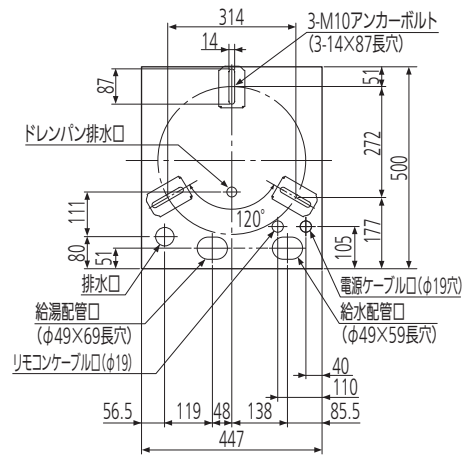

配管、アンカーボルト位置  
上面透視図

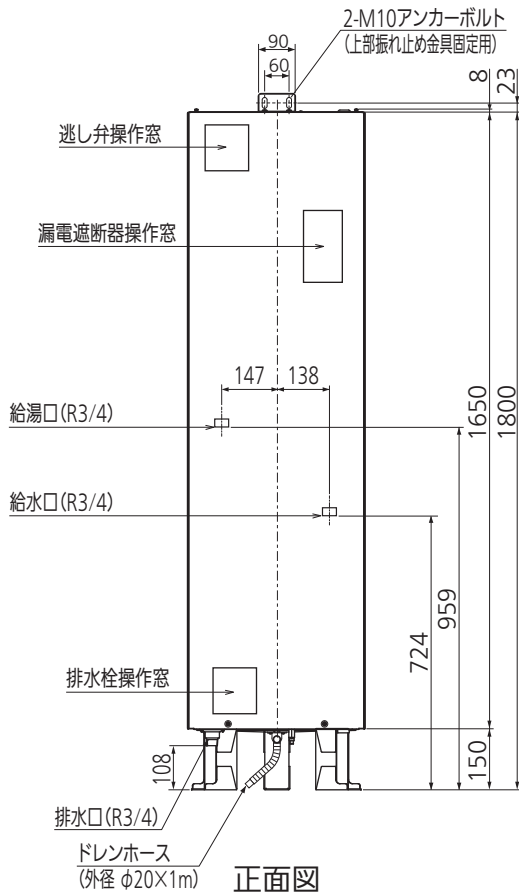

正面図

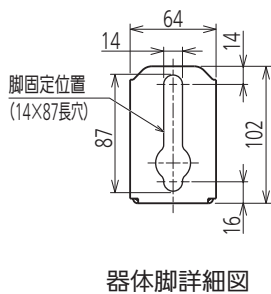

器体脚詳細図

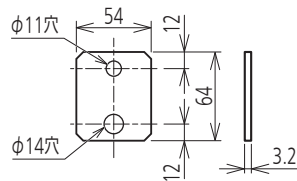

2穴平座金 (同梱部品)

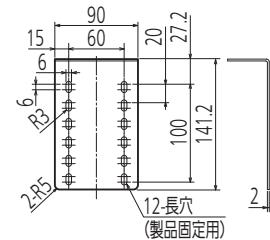
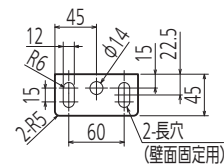

上部振れ止め金具 (同梱部品)