

4.外形寸法図

(寸法単位:mm)

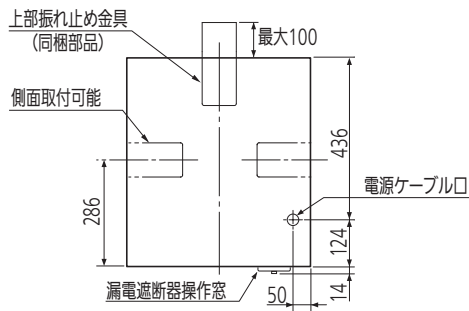

上面図

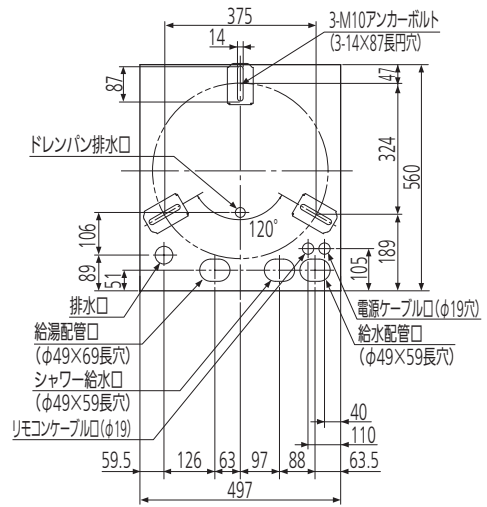

配管、アンカーボルト位置
上面透視図

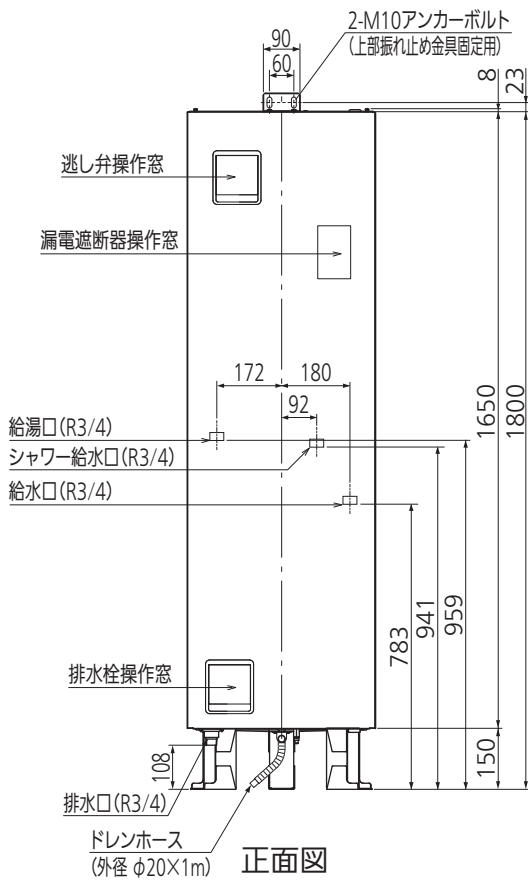

正面図

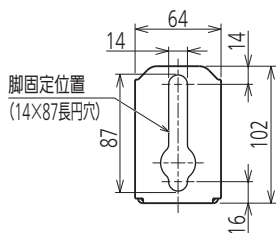

器体脚詳細図

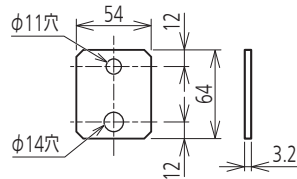

脚固定金具 (同梱部品)

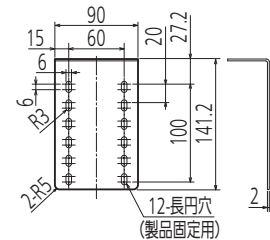
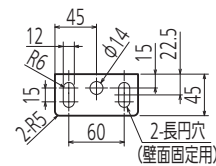

上部振れ止め金具 (同梱部品)